

# Equipment Specification

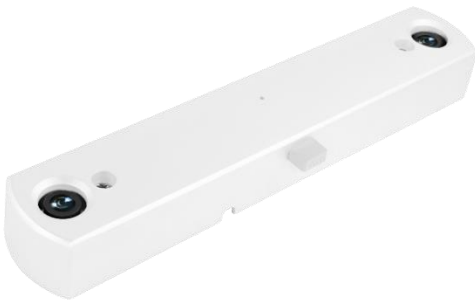

### FootfallCam 3D Plus-LC™ FC-F3DP01

FootfallCam 3D Plus-LC™ is specially designed for retail stores which have low ceiling (2.1m-2.4m). FootfallCam 3D Plus-LC™ embedded with a powerful 1GHz processor, specifically to run its complex video processing algorithm. Our GPU Processor is powered by the latest algorithm which uses both colour and texture pattern to identify the person, producing far superior accuracy than when using colour pattern alone. FootfallCam is equipped with lenses which provide super wide-angle view in ensuring good depth of view as compared to telephoto lenses. The wide field of view will also make sure a complete coverage to achieve the highest accuracy.

#### Key Features

- Stereo Vision Technology
- Bi-directional counting
- Accurate Counting with Video Proof
- Leading Image processing technology
- Most powerful processor
- Dual Operating System
- Hardware Watchdog
- Flush Mounting Compatible
- Privacy Secure
- Easy to Install and Set Up
- Power over Ethernet

Power Unit Specifications	
Power Over Ethernet (PoE)	Yes (IEEE802.3at)
PoE Mode	Mode B
Consumption	5w
AC input	110V – 240V, 50/60Hz

Software Specifications	
Interface	Http; Https
User Levels	2 levels: Administrator, Standard User
Operating System	Footfall Counter OS
Ethernet	10/100 Mb Ethernet
Time	NTP, Adjustable time zone, automatic day light saving adjustments
Data Delivery	TCP/IP
Database Type	SQLite
Report format	csv, .xml, .txt
Data Storage	50 Years storage with auto sync
Data Backup	Yes

Counter Tracking Coverage Table	
Ceiling Height	Coverage Area
2.1	1.47 x 1.32 m
2.2	1.66 x 1.49 m
2.3	1.84 x 1.65 m
2.4	2.29 x 1.82 m



#### 5x Metrics in 1 Counter

##### 1. Visitor Count

Counting Ins and outs, (measure store performance, find out if bad performing stores were due to low footfall or bad sales effort, measure marketing response.)

##### 2. Window conversion rate

Measure if any promotional campaign or shop window display has driven traffic.

##### 3. Returning Customer Tracker

Track whether they are the returning customer since every customer would have their unique identifier by using smartphone

##### 4. Dwell Time

Measure the duration of the customers stay in the stores

##### 5. Cross Shopping

Identify cross shoppers by comparing the unique identifier and detecting the matching unique identifier in different stores.

Key Specifications	
Device Dimension	Device dimensions (WxDxH): 246mm x 46mm x 28mm Packing dimensions (WxDxH):255mm x 210mm x 55mm
Weight	Device weight: 0.6 kg; Package weight: 1.02kg
Cameras	2x 5MP resolutions Lens: Parabolic 140° - Specially designed lens to facilitate the focus of 3D images at extreme close range.
Ideal Mounting Height	2.1 metres-2.4 metres
Casing	Aluminum oxide alloy, Water and dust resistant
Field Upgradable	Auto Software upgrade
Power	Power over Ethernet: 47V DC, 0.12A (6W)
Illumination	Minimum 300 lux
LEDs	LEDs troubleshooting for counting issues
Environmental Specs	Operating environment: Temperature 10°C to 45°C, Humidity 10% - 90% Storage environment: Temperature -40°C to 80°C, Humidity 10% - 95%
Output	5MP Omni vision 5647 Camera Module
Frame Rate	15 fps - Live Stream will only display 320x420 resolution to reduce bandwidth sent to database for verification purpose
Storage	Micro SD, 8 GB memory
Cabling	Cat5, Cat6
Tracking Technology	3D- Spacing Mapping Video tracking technology, Background removal on static objects
Firmware Feature	Dual Operating System, Hardware watchdog, Multicore processor
IP Rating	IP 31
Origin	Made in the UK

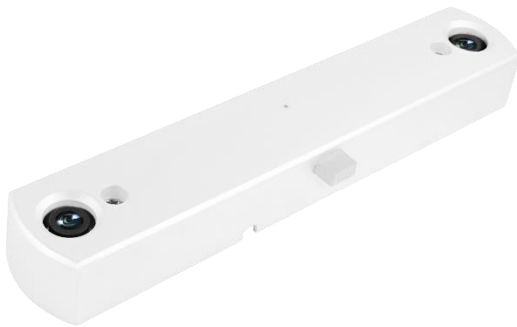

### FootfallCam 3D Plus-NC™ FC-F3DP02

FootfallCam 3D Plus-NC™ is suitable for the ceiling height (2.5m-3.5m) and is embedded with a powerful 1GHz processor, specifically to run its complex video processing algorithm. Our GPU Processor is powered by the latest algorithm which uses both colour and texture pattern to identify the person, producing far superior accuracy than when using colour pattern alone. FootfallCam is equipped with lenses which provide super wide-angle view in ensuring good depth of view as compared to telephoto lenses. The wide field of view will also make sure a complete coverage to achieve the highest accuracy.

#### Key Features

- Stereo Vision Technology
- Bi-directional counting
- Accurate Counting with Video Proof
- Leading Image processing technology
- Most powerful processor
- Dual Operating System
- Hardware Watchdog
- Flush Mounting Compatible
- Privacy Secure
- Easy to Install and Set Up
- Power over Ethernet

Power Unit Specifications	
Power Over Ethernet (PoE)	Yes (IEEE802.3at)
PoE Mode	Mode B
Consumption	5w
AC input	110V – 240V, 50/60Hz

Software Specifications	
Interface	Http; Https
User Levels	2 levels: Administrator, Standard User
Operating System	Footfall Counter OS
Ethernet	10/100 Mb Ethernet
Time	NTP, Adjustable time zone, automatic day light saving adjustments
Data Delivery	TCP/IP
Database Type	SQLite
Report format	csv, .xml, .txt
Data Storage	50 Years storage with auto sync
Data Backup	Yes

Counter Tracking Coverage Table	
Ceiling Height	Coverage Area
2.5	2.86 x 2.34 m
2.7	3.34 x 2.73 m
3.0	4.05 x 3.33 m
3.3	4.77 x 3.93 m
3.5	5.24 x 4.33 m
3.7	3.49 x 2.87 m
4.0	3.92 x 3.23 m
4.3	4.36 x 3.58 m
4.5	4.65 x 3.82 m

#### 5x Metrics in 1 Counter

##### 1. Visitor Count

Counting Ins and outs, (measure store performance, find out if bad performing stores were due to low footfall or bad sales effort, measure marketing response.)

##### 2. Window conversion rate

Measure if any promotional campaign or shop window display has driven traffic.

##### 3. Returning Customer Tracker

Track whether they are the returning customer since every customer would have their unique identifier by using smartphone

##### 4. Dwell Time

Measure the duration of the customers stay in the stores

##### 5. Cross Shopping

Identify cross shoppers by comparing the unique identifier and detecting the matching unique identifier in different stores.

Key Specifications	
Device Dimension	Device dimensions (WxDxH): 246mm x 46mm x 28mm Packing dimensions (WxDxH):255mm x 210mm x 55mm
Weight	Device weight: 0.6 kg; Package weight: 1.02kg
Cameras	2x 5MP resolutions  Lens: 90° - Versatile ceiling height range. Accommodate most installation environment
Ideal Mounting Height	2.5 metres-3.5 metres
Casing	Aluminum oxide alloy, Water and dust resistant
Field Upgradable	Auto Software upgrade
Power	Power over Ethernet: 47V DC, 0.12A (6W)
Illumination	Minimum 300 lux
LEDs	LEDs troubleshooting for counting issues
Environmental Specs	Operating environment: Temperature 10°C to 45°C, Humidity 10% - 90% Storage environment: Temperature -40°C to 80°C, Humidity 10% - 95%
Output	5MP Omni vision 5647 Camera Module
Frame Rate	15 fps - Live Stream will only display 320x420 resolution to reduce bandwidth sent to database for verification purpose
Storage	Micro SD, 8 GB memory
Cabling	Cat5, Cat6
Tracking Technology	3D- Spacing Mapping Video tracking technology, Background removal on static objects
Firmware Feature	Dual Operating System, Hardware watchdog, Multicore processor
IP Rating	IP 31
Origin	Made in the UK

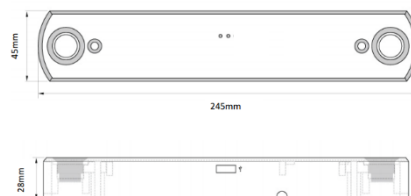

### FootfallCam Midspan FC- FPS01

FootfallCam Power over Ethernet Midspans offer an easy, fast, and cost-efficient solution for powering network products over ethernet without the need of installing power outlets and electrical cabling. FootfallCam Midspans are connected to the power source transmitting the power and injecting it into the network cable to enable FootfallCam People Counter to receive data and over the same ethernet cable. The Midspan makes it easier to install network video products such as the FootfallCam 3D+ in areas where power cabling and outlets are unavailable. With the usage of the FootfallCam Midspan, the installation of the FootfallCam People Counter 3D+ only requires 1 cable to function.

#### Features and Function

##### Function

Data and power are fed to a network video product through an Ethernet cable

##### Installation

- Plug and play installation
- Automatically detects PoE and high PoE enabled devices and supplies inline power
- Local LED management display to indicate power transference

##### Casing

FC-FPS01: Indoor polycarbonate. IP66-/NEMA 4x-Rated

##### Compatibility

Compatible with FootfallCam 3D+™

All FootfallCam 3D+™ comes with built in PoE support that is fully capable to support both singular PoE Injector and PoE Switches



#### Specification

<b>Model Number</b>		FC- FPS01
<b>Connector</b>		RJ – 45 x2 (Data In/Data and Power Out)
<b>Dimensions</b>	L X W X H	88 x 51 x 166 mm
	Weight	350g
<b>Ethernet Data Rate</b>		10/100/1000 Mbps (varies based on Ethernet device attached)
<b>Power</b>	Input	AC 90 to 260 V, AC Socket
	Output	30 W DC at 54V
<b>Power Cord</b>		US/UK/EU/AU Plug type
<b>Ethernet Cable</b>		TIA/EIA – 568 Category 5/5e/6 Cable
<b>Power Pin Define</b>		Power Pin in Mode B (Pin 45+/78-)
<b>LED Indicator Light</b>		Power Enable PoE Power Feeding
<b>Temperature</b>	Usage	0 to 40 Degree C, 5~90% RH
	Storage	-10 to 70 Degree C, 5~90% RH
<b>Emission</b>		FCC Class B, CE Mark
<b>Standard Compliance</b>		IEEE 802.3 Ethernet IEEE 802.3u Fast Ethernet IEEE 802.3ab Gigabit Ethernet IEEE 802.3af Power over Ethernet IEEE 802.3at Power over Ethernet
<b>Certification</b>		EC Declaration of Conformity FCC Declaration of Conformity

### FootfallCam Analytic Manager V8™ FC-FAMV801



#### Centralised Management Analytics Software

FootfallCam Analytic Manager V8™ is enterprise web-based control panel designed for customers who are managing large number of counters. It collects data from all counters and store them in a single place where user can carry out deep analytics. Analytic Manager V8™ provide the full analysis of traffic data for individual stores and across multiple store locations, region and the entire chain including:

- (a) **Visitor entering and exit at the entrance,**
- (b) **Sales conversion,** and
- (c) Other Wi-Fi metrics like **passerby, visit duration, returning customer** and etc.

#### Key Features

- Easy to Set Up
- Available on web, tablet and mobile
- Counter and Branch Details Configuration
- Pre-defined 15+ Reports and 60+ KPIs
- Health Check Monitoring
- Import Sales Data for comparison with Footfall
- Data Export or Integrate with 50+ Business System
- Account Management
- Email Scheduler
- Regular Backup
- Support Multi Language

#### Pre-Defined Report Set

15+ pre-defined reporting set designed for different functional role e.g. Top management at headquarter, Marketing Manager, Operation Manager, Regional Manager or Store Manager. There are Company level report set which could provide the overall insight of the store performance in macro view, and store level report set which provide the further insight of the footfall pattern and shopper behavior in deep for any operational and marketing decision.

#### Health Check Report

A routine system health check is implemented, which check across the whole system to make sure all counters are connected and counting. This health check is usually scheduled to perform daily at a pre-defined time (e.g. 12am). An automated email alert will be sent to the person-in-charge detailing any faults found, making this a pro-active yet manageable approach to maintain all the counters across your retail chain

#### User Account Management

Different users may have different job responsibilities and need to use the FootfallCam Report Manger TM in different ways. Individual user accounts can be setup for your team member, and access rights assigned accordingly. Every user will be assigned a user ID and password, which they will be able to access from any networked location. System administrator will have remote access to the accounts information, modify access rights and disable any account when a team member leaves the company

#### Automate Email Scheduler

Reports can be scheduled to be sent to the key person (e.g. store manager for the store weekly reports, marketing manager for the campaign effectiveness reports, etc.) via email on a regular basis

#### API Available for Data Integration

API are available to import or export data to and from a system. FootfallCam is a fully embedded software module, intended for any environment where store footfall counting is required. Business intelligence (BI) system extracts and analyses footfall data (from FootfallCam central server) together with ePoS data (from retailer's ePoS system) to produce management report for corporate strategic planning

Minimum Server Requirements	
Operating System	Windows 7/ Window Server 2008 R2 and above
Storage	2TB support up to 1000 Devices
Memory	8GB
Processor	Intel(R) Xeon(R) CPU D-1521 @ 2.40GHz, 2401 MHz, 4 Core(s), 8 Logical Processor(s)
Physical Memory	32 GB
Web Server	Internet Information System (IIS) 7.0 and above
Microsoft .NET Framework Version	4.0

Software Specifications	
Interface	Http; Https
Compatible Browser	IE7 or Later Mozilla Firefox or Later Chrome Version 4.0 or Later Safari
User Levels	2 levels: Administrator, Standard User
Ethernet	10/100 Mb Ethernet
Time	NTP, Adjustable time zone, automatic day light saving adjustments
Data Delivery	TCP/IP
Database Type	SQLite
Report format	csv, .xml, .txt
Data Storage	5 Years storage with auto sync
Data Backup	Yes
Backup Frequency	Daily Full Backup for Data and Configuration File Weekly Backup to Sub Server for Contingency Purpose
Software Version Upgrade	Auto Upgrade

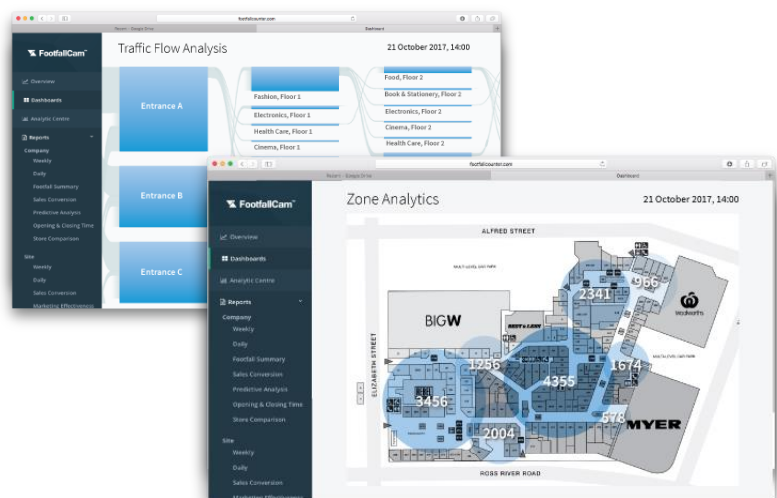

**Accessories**

**FootfallCam PoE Switch** FC- FPS02/03/04



FootfallCam PoE Switch provides multiple adaptive RJ45 ports that are used for connecting multiple people counters in a singular location with support on MDI and MDIX auto flipping and wire-speed forwarding. All ports have a PoE function that support IEEE 802.3af / at standard and can be used as an ethernet powered device to automatically detect and provide power to any power receiving devices that meets the standard through a network cable. The FootfallCam PoE Switch is simple and easy to use, with no configuration, and is a plug and play device.

**Features and Function**

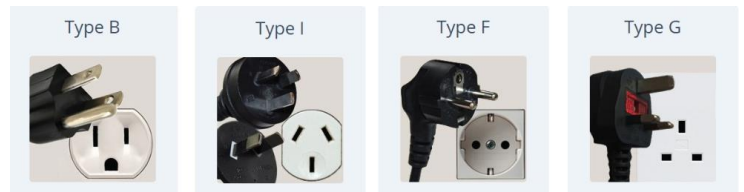
- Built in power supply
- Supports 10/100 Base-T applications
- Compact design is ideal for WLAN access
- Plug and play without configuration
- Electrical Safety: Low power devices only receive the power they need
- IEEE 802.3at up to 30W POE port
- Ethernet Terminals
- Internal Power Supply



**Specification**

				
<b>Model Number</b>		<b>FC- FPS02</b>	<b>FC- FPS03</b>	<b>FC- FPS04</b>
<b>Number of Ports</b>		4	8	16
<b>Dimensions</b>	L X W X H	185 x 118 x 44mm	185 x 118 x 44mm	185 x 118 x 44mm
	Weight	800g	800g	800g
<b>Protocol Standard</b>		CSMA / CD IEEE 802.3, 802.3i, 802.3u, 802.3af, 802.3at, 802.3x		
<b>PoE Spec</b>		PoE over current protection PoE circuit sorting protection Power Pin Assignment: 1/2 (+), 3/6 (-)		
<b>Transmission Media</b>		10 BaseT Cat 3,4,5 UTP/STP 100M BaseTx Cat 5 UTP/STP		
<b>System Mode</b>		Standby		
<b>LED Indicator Light (Per Port)</b>		PoE In Use (Orange) 10/100 Link/Act (Green) Green: Power		
<b>Network Interface</b>		4 x 10/100Mbps RJ-45 PoE 2~5 Ports 4 x 10/100Mbps RJ-45 Uplink 1 Ports		
<b>PoE Power Supply</b>	PoE Standard	IEEE802.3af / at		
	Port Power	Maximum 30 W		
	Total Power	Maximum 65 W		
	PoE Power	Maximum 60 W		
	Priority	Standby		
<b>Performance</b>	Store and Forward	Standby		
	Exchange	1.0 Gbp/s		
	Mac Address Depth	2k		
<b>Power Supply</b>	Consumption	Maximum 65 W		
	Input	100 – 240 AC, 50/60 Hz, 2A Internal Power Supply		
<b>Temperature</b>	Usage	0 °C ~ 40 °C; Operating humidity: 10% ~ 90% RH non-condensing		
	Storage	-40 °C ~ 70 °C; Storage humidity: 5% ~ 90% RH non-condensing		

Accessories



FootfallCam Drop Pole

FC-DP02

The FootfallCam Drop Pole allows installation of a FootfallCam device when the ceiling height of the store is outside of the recommended range (6m – 7.5m), and wall bracket is not suitable.

Dimensions

Key Specifications	
Compatible with	FootfallCam 3D Plus
Weight	5.8 kg
Material	Metal
Extension Reach	1.5m to 3m
Environment	Indoor
Ideal Mounting height	6m to 7.5m (measure from floor)
Included	FootfallCam Mounting Plate Screwing Kits

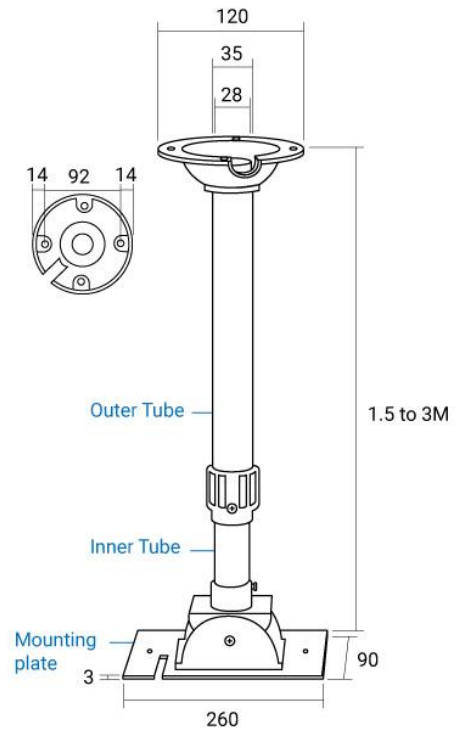

How to Install Flush Mounting Plate

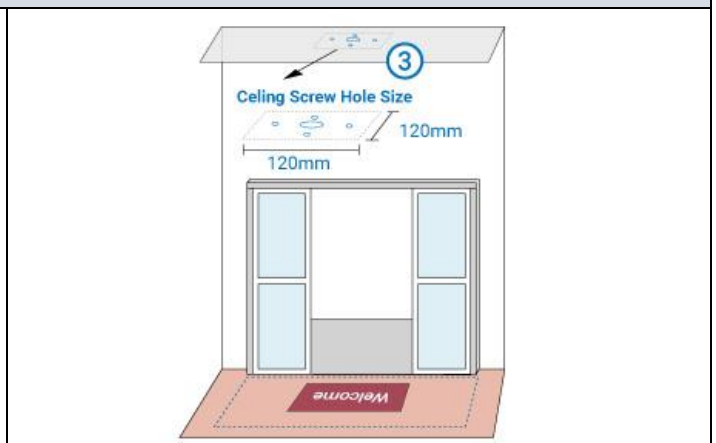
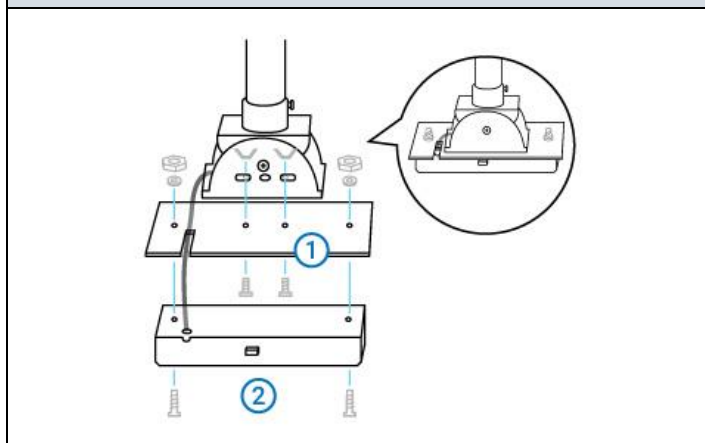

**Step 1:** Attach the mounting plate to the drop pole using the internal screws, then attach the counter to the mounting plate using the external screws.

**Step 2:** Determine the mounting location and drill (5) holes for installing the drop pole. The holes should be drilled within (120mm x 120mm)

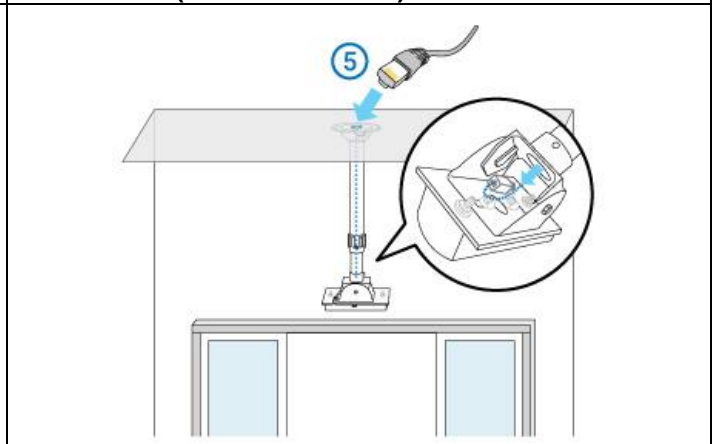
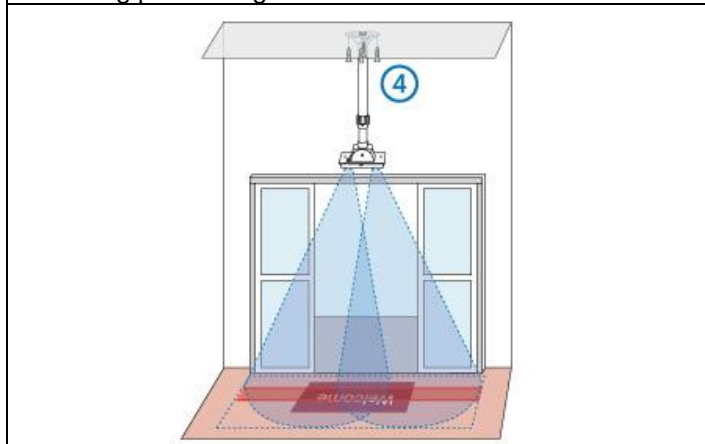

**Step 3:** Mount the drop pole onto the ceiling.

**Step 4:** Connect the Cat5 cable through the tubes of the drop pole.

Accessories

FootfallCam Flush Mounting Plate Kit FC-FMP04

The FootfallCam Flush Mounting Plate designed to provide a better outlook and fit for the store design.

Dimensions

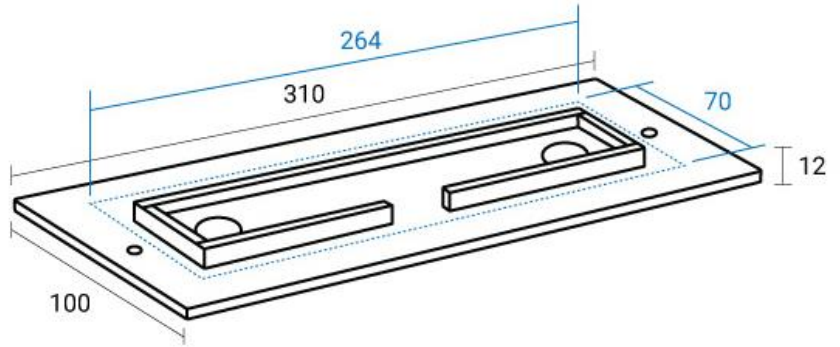

Key Specifications

Compatible with	FootfallCam 3D Plus
Dimension	(WxDxH): 310 x 100 x 12mm
Ceiling Hole Size	(WxD) 264 x 70 mm
Maximum Load	1kg
Weight	500 g
Thickness	3.0 mm
Material	Acrylic
Color	White transparent
Environment	Indoor
Ideal Mounting height	2.8 m -3.5 m (measure from floor)
Included	2x ceiling screws, 2x wall plugs



How to Install Flush Mounting Plate

<p><b>Step 1:</b> Determine the mounting location (ideal height: 2.8m – 3.5m), cut the hole of camera space for installing the mounting plate (264mm x 70 mm)</p>	<p><b>Step 2:</b> Attach the counter to the bracket.</p>	<p><b>Step 3:</b> Mount the plate with camera on the wall with 2x screws and wall plugs.</p>



Accessories



**FootfallCam Wall Bracket Kit** FC-WB03

In some environments, counters may not be able to mount on the ceiling, or the ceiling height is outside the recommended range (2.8 m – 3.5 m). In those cases, a wall mount bracket would be recommended.

Dimensions

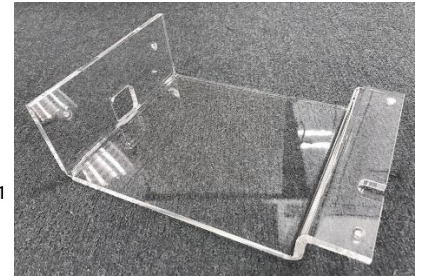
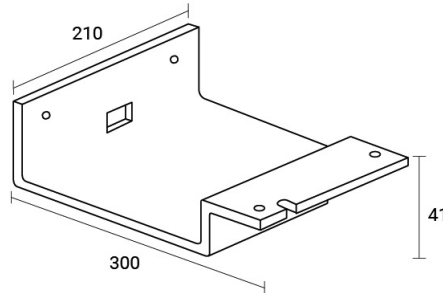

Key Specifications

Compatible with	FootfallCam 3D Plus
Dimension	(WxDxH): 210 x 300 x 41mm
Maximum Load	1kg
Weight	800 g
Thickness	8.0 mm
Material	Acrylic
Color	White transparent
Environment	Indoor
Cable Routing	Cable holes & Cable Clips
Ideal Mounting height	2.8 m -3.5 m (measure from floor)
Included	2x ceiling screws, 2x wall plugs, 2x bolts, 2x nuts, 2x washers



How to Install Wall Bracket

<p><b>Step 1:</b> Determine the mounting location (ideal height: 2.8m – 3.5m), calculate the total counter required using <a href="#">FootfallCam Calculator</a></p>	<p><b>Step 2:</b> Attach the counter to the bracket with 2x screws, nuts and washers.</p>	<p><b>Step 3:</b> Mount the bracket on the wall with 2x screws and wall plugs.</p>

# FootfallCam Analytic Manager V8™

FootfallCam Analytic Manager V8™ is enterprise **web-based control panel** designed for customers who are managing large number of counters. FootfallCam's cloud based services offer to users without any additional charge or monthly fees. Users data are stored in the cloud by default without any limits on the amount of data stored and the duration stored on the cloud will be lifetime or until end of business of FootfallCam. It collects data from all counters and store them in a single place where user can carry out deep analytics. Analytic Manager V8 provide the full analysis of traffic data for individual stores and across multiple store locations, region and the entire chain including:

- (d) **Visitor entering and exit at the entrance,**
- (e) **Sales conversion,** and
- (f) Other Wi-Fi metrics like **passerby, visit duration, returning customer** and etc.

For more information, please refer to [FootfallCam Analytic Manager V8 Datasheet](#).

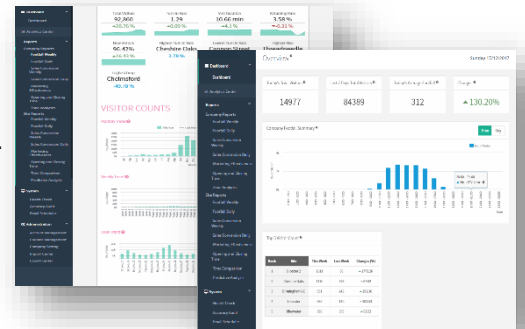

## 2.1 Server Options

FootfallCam Analytic Manager V8™ Server Options:

	FootfallCam Cloud Server	Install at Client's Corporate Server
Descriptions	Software and data stored at FootfallCam hosted server. Retailer able to access via web browser with a secured password or login account.	Software and data stored at retailer's own corporate server. Retailer will be given full access to the software which is having the same function as cloud based software.
Pricing	Free	One-off set-up fee is required for number of device less than 50 units
Software Core Features		
Max Number of Devices	Unlimited	Support up to 2000 devices with 2TB storage
Analytics and Reports	Yes	Yes
Email Scheduler	Yes	Yes
Compare data by store, by time and by different metrics	Yes	Yes
Custom Dashboard created by user	Yes	Yes
User Account Management	Yes	Yes
Health Check Reports	Yes	Yes
Accuracy Audit Function	Yes	Yes
Sales Data/ POS Integration	Yes	Yes
Data Export in csv, pdf, txt and excel format	Yes	Yes
Counter and Branch Management	Yes	Yes
Multi Language	Yes	Yes
Remote Access to the counter	Yes	Yes, provided the device is within the same network
Firmware Upgrade	Automate	Automate, however customer able to control the quantity upgrade per day
Software upgrade	Automate	Automate
Backup and Security Protection		
Data backup	Automate daily backup in cloud server	Backup function available for retailer to set up your own backup
Configuration setting backup	Automate daily backup in cloud server and client's server	Automate daily backup
Contingency backup	Weekly backup to sub server	Not Available
Data Protection	Yes	Yes

## 2.1.1 Installing in Client's Corporate Server Requirement

Customers will have the option to install FootfallCam's software in their very own server. Software and data will be stored at retailer's own corporate server only. Customer will be given full access to the software which is having the same function as cloud based software with all the latest updates and features. Customers will have more control over the software such as limiting the quantity of firmware upgrade per day. Installing at customer's own server aligns with customer's data protection policy where all data should only be in their restrictive network for security concerns.

### Workflow for Server Installation

- I. For clients without any existing cameras, they will only need to request for the server installation to the account manager and once a request is placed with FootfallCam and payment is made, FootfallCam will schedule a time with client to book in for installation.
- II. Client will install and provide Teamviewer access to FootfallCam team
- III. It takes 2 hours to complete the server installation
- IV. FootfallCam will provide access details to clients via email upon completion of installation

### Workflow for Server Migration

- I. Client can choose to use FootfallCam's cloud server first, then at a later stage, if they prefer to have their own server with FootfallCam's software, they can request from us and we will assist them by migrating all their existing information from our cloud to their server.
- II. FootfallCam's team will perform several procedures to migrate the server. Firstly, we would back up the data of the previous server.
- III. Similar to server installation, we would need to install our FootfallCam software onto client's server which takes about 2 hours to complete
- IV. Once our software has been installed, our technical team will begin transferring all the existing data to the new server and restoring the previous data up to the new server.
- V. Then, we will reconfigure all the existing counters are sending the data to the correct server by connecting to each counter and change its IP address to the updated IP address.

For server requirement and more information, please refer to [FootfallCam Analytic Manager V8 datasheet](#)

## 2.2 Data Import and Export

FootfallCam is a fully embedded software module, intended for any environment where store footfall counting is required. Business intelligence (BI) system extracts and analyses footfall data (from FootfallCam central server) together with ePOS data or staff labour hours (from retailer's ePOS system or staff management system) to produce management report for corporate strategic planning.

There are several methods of [importing sales data/staff labour hours](#):

- FTP sales data to FootfallCam server
- Provide FTP Directory of your store to us
- Manually upload whenever required

There are several methods in [exporting counting data](#):

- FTP via each counter (raw data only)
- Export from server software (aggregated data from branch level in hourly/daily format)

We have an API module available for customers to obtain the data. For more information, please refer to [FootfallCam API Documentation](#)

# Services

### 3.1 Sales Consultation

FootfallCam provides professional sales consultation services to clients by carefully listening to their requirements and what they are looking for. FootfallCam representative will assign an **account manager** to specially dedicated to serve the client to handle the entire project with them. The representative will serve as a single point of contact for the client, to better manage and provide quicker feedback loop between client and FootfallCam. Alternatively, clients may also contact our support centre directly for issues relating to operating system and general enquiries. Support Hours:

**Asia Office**

Opening Hours: 9:00 A.M. to 6:00 P.M. Monday – Friday (G.M.T +8)  
 Telephone support line: +60 3-9011 2413  
 Email: [support@footfallcam.com](mailto:support@footfallcam.com)

**Europe Office**

Opening Hours: 9:00 A.M to 5:00 P.M Monday – Friday (G.M.T)  
 Telephone support line: +44 (0)1344 988681 or +44 (0)1344 988650  
 Email: [support@footfallcam.com](mailto:support@footfallcam.com)

#### 3.1.1 Project Tracker

The dedicated account manager will provide an update on the project progress. It aims to provide **visibility** on the project for the client and better manage the project to meet the **timeline**. Clients are also encouraged to provide constructive feedback and convey their requirements in order for FootfallCam team to direct the project in meeting their aims of this project. This project tracker includes several parts that each serves a purpose on its own, here is the breakdown of the basic structure of the project tracker as reference:

- a) Installation Summary to Date
- b) All Existing Devices' Health Check Update
- c) Data Readiness Timeline
- d) Important Reports
- e) Deeper Analytics on Existing Reports
- f) Targeted Timeline
- g) Summary/ Future Plans



## 3.2 Installation Support

FootfallCam 3D Plus is fitted on the entrance for each store. and It would require only one Cat5e cable connect from the counter to the back-office router via PoE injector, which would combine both network and power cable. FootfallCam 3D plus is a standalone computer unit which will carry out video analytics, hence no PC is required in the store.

Clients have the option to use FootfallCam's service for installation or they have the option to use their very own engineer to perform the installation. FootfallCam's installation process is upright straightforward and easy to perform, hence any electrician or handyman will be able to perform the installation as well. For a reasonable store size, an installer would normally take no longer than 2 hours per store to complete the entire installation to get the devices up and running.

Installation Options	Method of Communication	Description	Cost
FootfallCam's Engineer	FootfallCam's Internal Communications	<ol style="list-style-type: none"> <li>1) FootfallCam will arrange own engineer to perform the installation, the installers are very experienced and able to install devices at optimal position within short period of time</li> <li>2) FootfallCam work with our local contractors and partners in delivering the <b>installation service in the local country</b></li> <li>3) FootfallCam's dedicated account manager will <b>project manage</b> the whole installation progress and ensure the delivery of the product</li> </ol> <p>Please fill up this <a href="#">checklist</a> and send it to <a href="mailto:sales@footfallcam.com">sales@footfallcam.com</a> to book in for an installation</p>	Chargeable
Clients' Own Installer	Instant Messaging (WhatsApp)	<ol style="list-style-type: none"> <li>1) FootfallCam will conduct training with installer prior to installation to explain on Do's and Don'ts of the installation process</li> <li>2) Please inform FootfallCam at least <b>24 hours</b> prior to installation and email to <a href="mailto:support@footfallcam.com">support@footfallcam.com</a> to notify FootfallCam to be on standby and support the installation</li> <li>3) When the installer arrives at site, they would need to <b>take picture of the store</b> and send to the WhatsApp for FootfallCam to advise on optimal camera positioning</li> <li>4) Once it is installed, installer would need to access the camera and send over <b>screenshots</b> of the IT settings</li> <li>5) Once the counter is <b>blue</b> and ready to go, FootfallCam will inform the installer that it is good to leave the site and head for the next installation</li> </ol>	Free

## 3.3 Counting Lines Calibration

After every installation of a FootfallCam, it is important that it achieves more than **90% accuracy level**. Every counter can be calibrated by client themselves which is quite simple and easy to do by just referring to our user guide. In some uncommon situations, clients may not know how to calibrate the counters, then they may seek help from our calibration specialist team to perform it for them. FootfallCam has a **specialised team** in calibrating the counting lines of the counter to ensure maximum accuracy is achieved for that counter. Once the counter is calibrated with the counting lines, there would be an accuracy audit process which will generate a report on the accuracy level of each individual counter. Each counter's system count will be manually verified against manual count to verify its accuracy.

If a client wishes to seek service from FootfallCam, they would need to just fill up this [FORM](#) and send it to our email at [support@footfallcam.com](mailto:support@footfallcam.com) and the calibration would take **3 working days** and for the full accuracy auditing will take up to **7-14 days** to collect enough sample size.

During the accuracy auditing, there would be an audit video uploaded to the server (approximately 25mb per video and 3x videos would require for tuning purpose) and it recorded for tuning and reporting purpose, once completed, it would stop sending to the central server after the counter has been verified. If it does not hit the satisfactory accuracy, the user may submit a [re-verification request form](#) and allow FootfallCam verification specialists configure the counting settings.

Please refer to our [user guide](#) Section 4 for more information on this counting line calibration and accuracy audit process.

## 3.4 IT Consultation

FootfallCam offers IT consultation services which we will work with client's IT team to go through their requirements. In the event there are any IT issues, they may consult us as well, since we are the manufacturer or both hardware and software, we well versed with our in-house products and we are able to solve any issues with a shorter turn-around time in comparison with other people counting solution providers.

Below are listed some of the IT consultation service we offer:

- a) Server set up and configurations
- b) Networking configurations
- c) System/software upgrade
- d) Data Integration
- e) Software Configuration
- f) Bugs reporting/feedback

Please contact us via email at [support@footfallcam.com](mailto:support@footfallcam.com) or call us at +44 (0)1344 988650



## 3.5 Support Contracts

This Agreement represents contract between FootfallCam and Client for the provisioning of services required to support the People Counting system. This Agreement remains valid until superseded by an amendment to this Agreement which has been approved by both parties.

There are two plans that client may opt for;

### I. Standard Plan

#### In Standard Plan, we offer reactive support approach

- ✓ Counting Line Calibration and Accuracy Audit
- ✓ Assist the Client to answer technical enquiry and ensure full operational system
- ✓ Counter Reconfiguration
- ✓ Client to provide IT staff to actively monitor the health check status on the counter and identify the issue
- ✓ Each FootfallCam will send heartbeat to the health check report every 15 minutes, and the aggregated Health Check report will be provided by FootfallCam
- ✓ First line, second line and onsite support
- ✓ Reinstalling server software on Client's new server
- ✓ Reporting software and database support maintenance
- ✓ Software/ Firmware upgrades
- ✓ Telephone/ Email assistance

### II. Premium Plan

#### In Premium Plan, we offer proactive support approach

- ✓ Include all of the terms in Standard Plan
- ✓ FootfallCam provide comprehensive cover in all aspect in the system operational standard
- ✓ FootfallCam provide dedicated support staff to work with the Client
- ✓ FootfallCam will proactively manage the health check status and data integrity of the system

Please refer to your account manager to seek advice on which plan would be more suitable for client. If a client wishes to sign up for a plan, it must be subscribed within 3 months of purchase date, otherwise there would be extra charges incurred. Termination of the plan will need to have a month notice and reactivation will incur extra charges.

Kindly contact your respective account manager to draft a support contract for you to sign to subscribe, alternatively you may request it by dropping an email at [sales@footfallcam.com](mailto:sales@footfallcam.com)

## 3.6 Software Training

Every client will be able to request for a software training session with FootfallCam team, this includes;

- a) Navigation of Control Panel and its Configurations
- b) Generating Reports
- c) Comparison of Sites/Branches by Metrics
- d) Creating Own Dashboards
- e) Set up Email Scheduler
- f) Verification (Accuracy Audit) Process
- g) Creating User accounts

Software Training Audience	Method of Training	Description	Cost
Headquarters	Remote	FootfallCam is able to conduct training to client's headquarters' staff remotely via Skype or Google Hangout	Free
	On-Site	There would be a representative from FootfallCam to conduct the training at clients' office	Chargeable
Store-Level	Video Training	Referring to our website and readily available training materials and perform self-learning	Free
	Remote	FootfallCam is able to conduct training to client's stores' staff remotely via Skype or Google Hangout	Free
	On-Site	There would be a representative from FootfallCam to conduct the training at clients' office	Chargeable
	Video Training	Referring to our website and readily available training materials and perform self-learning	Free

Please refer to our pricelist for more information on the price.

# Order & Delivery Details

## 4.1 Number of Counters Required

FootfallCam developed an advanced calculator to determine the number of units that is required for your store based on the **Ceiling Height** and **Entrance Width**. When more than one unit is required, it requires overlapping of coverage area to ensure that no miscount when people are entering right between the 2 counters. As shown in image below, the overlapping covered area overlaps to capture the middle person.

Please click here for the [FootfallCam calculator](#)

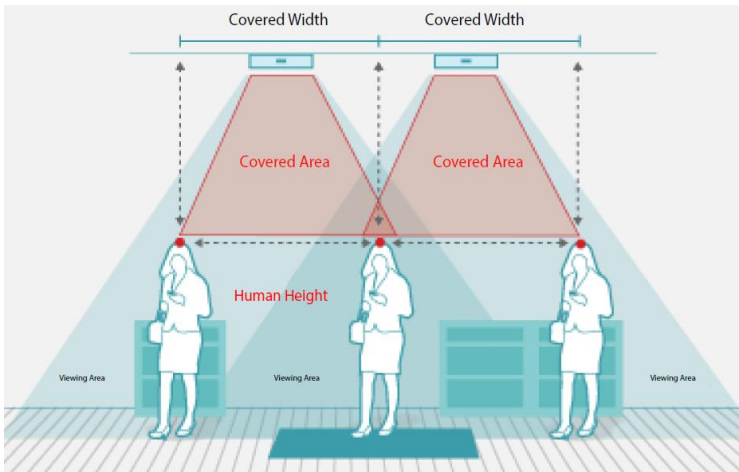

Ceiling Height (m)	Coverage Table
	2.10 m – 3.50 m
2.1	1.91 x 1.77 m
2.3	2.38 x 1.95 m
2.5	2.86 x 2.34 m
2.7	3.34 x 2.73 m
2.9	3.81 x 3.14 m
3.1	4.29 x 3.53 m
3.3	4.77 x 3.93 m
3.5	5.24 x 4.33 m
3.6	3.34 x 2.75 m
3.7	3.49 x 2.87 m
3.9	3.78 x 3.11 m
4.1	4.07 x 3.35 m
4.3	4.36 x 3.58 m
4.5	4.65 x 3.82 m

## 4.2 Payment Method

### I. Bank Transfer

- Details of Bank will be available in 2<sup>nd</sup> page of quotation
- Kindly bear for any bank chargers as we will **only consider fully paid** when the amount we received in the account is **exactly** as of quotation issued
- Takes a longer time for Telegraphic Transfer approximately **3-4 working days** depending on the bank
- We require all international transfers' payment instruction to be indicated as "**OUR**", this is to ensure buyer covers for all the bank charges involved
- Please provide us with the transfer slip once payment is made as proof of payment
- Order is confirmed when full payment received
- The quotation is strictly in this currency only, we do not accept any other currency, else the quotation is invalid

### II. PayPal

- Only recommended to use for low number of units (1-2 devices)
- There would be **high** PayPal charges incurred to **buyer**
- Immediate payment, we are able to prepare the units right upon payment

## 4.3 Shipment

### 4.3.1 Production Lead Time

Once an order has been confirmed, there is a production lead time for FootfallCam to process the order and prepare the units, it has to undergo several processes before a unit is ready. Each and every unit produced will be fully tested to minimize the defective units being sent to client. The lead time also depends on the number of units purchased. The table below shows the number of units and the estimated lead time for production respectively.

Production Lead Time	
Number of Units	Days for Production (Upon Order Confirmation and Upfront Payment)
1-50	3-5
51-200	7
201-500	14
501 and above	30

### 4.3.2 Delivery Lead Time

Once the units are prepared, it will be shipped out to the designated address provided. Our main Headquarters is located in UK while we have a warehouse over in Malaysia. Depending on the location of the client, we will be shipping out from the nearest office of ours to reduce delay and transit time to reach our customers. The average delivery time would be within **7 to 14** days, depending on the custom clearance.

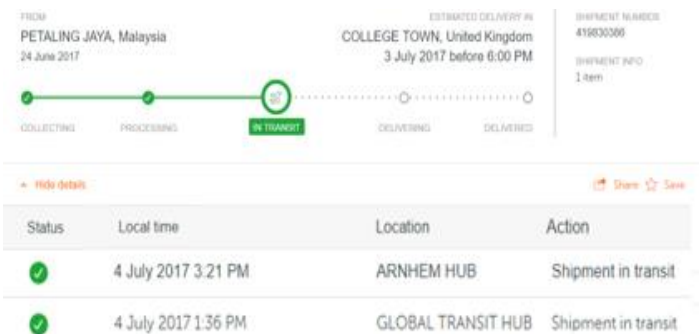

After the units are shipped, FootfallCam will send the **Tracking Details** to receiver, and from there on, it is the **receiver's responsibility to track the shipment** to know the status.

An example is shown below for the tracking details, customers will be able to track the progress of the shipment themselves. In the event if any documentation is needed from FootfallCam, we are reachable at our email at [sales@footfallcam.com](mailto:sales@footfallcam.com).

The delivery date of the products shown on the purchase orders is merely indicative and any delays with respect to this term shall not constitute grounds for claims or termination of the agreement. Particularly FootfallCam reserves the right to extend the delivery terms as well as to cancel the purchase order due to force majeure or in any case events which are beyond its will; such as changes in Customers' legal situation; difficulty in sourcing raw materials and component parts.

### 4.3.3 Dimension and Weight

Dimension and weight may vary according to the number of units ordered, below are listed the approximation of packaging breakdown:

Number of Units	Weight (KG)	Dimension (cm)
1	1.2	26 X 21 X 6
5	6	44 X 31 X 23
10	11	52 X 40 X 33

### 4.3.4 Courier Service

Delivery Options	Arrival Time	Cost
Standard*	7 to 14 days	Subject to delivery address
Expedited**	Within 7 days (Subjected to clearance)	
Customer's Shipping Account	Varies	Courier will be charge customer's shipping account directly

\*Standard Delivery option uses TNT, UPS or equivalent courier service

\*\*Expedited uses DHL or equivalent courier service

Depending on the region of consignee (receiver), FootfallCam will be sending out from the nearest FootfallCam warehouse. For Europe, Western, Central and Northern Africa region, units will be sent out from UK. For Asia and Eastern, Central and Southern Africa region, units will be sent out from Malaysia.

## 4.4 Duties and Taxes

Shipment	Buyer's Obligation	FootfallCam Obligation
Delivery Duty Unpaid (DDU)	Buyer will be responsible for import duties and taxes imposed on the shipment	FootfallCam will be responsible for transportation fee and assumes all risks until the goods have arrived at destination

Shipment will be under **DDU Incoterm** where FootfallCam is:

- I. **RESPONSIBLE** for the goods until destination indicated by consignee in Order Form.
- II. **NOT RESPONSIBLE** for any **Duties and Taxes** imposed on the shipment.

## 4.5 Custom Clearance Documents

FootfallCam will provide **Commercial Invoice** and **Packing List** for all our international shipments. Some of the important information that is in the commercial invoice are: Weight, Date, No. of Cartons, HS Code, Description and Unit Price. Customers will be **responsible** for all the import/custom requirements of the goods into customer's country.

## 4.6 HS Code

By default, FootfallCam will use **8525803000** HS Code which is the most accurate and favorable tax rate for most of the country. Clients may inform us in advance if they have a **preferred HS code** to be used for the shipment. Please check at customs website of client's country to validate this HS code, otherwise client may advise us any HS code that you deem to categorise the item more accurately. Here is the [list](http://tariffdata.wto.org) extracted from World Trade Organization for the tariff rate according to HS Code 8525 (Source: <http://tariffdata.wto.org>)

## 4.7 Warranty

All FootfallCam units have a comprehensive 12-months warranty that includes remote support, counter hardware, repair, and software updates. The warranty period starts automatically when the counter is allocated to the server software. You may download and read the [warranty terms and conditions](#) for further information.

RMA process is to help ensure that the user has access to a working camera as quickly as possible. Fill out the following [RMA form](#) and send us a **softcopy** and please remember to attach a **hardcopy onto** the parcel, failure to do so will **void** the warranty and not be considered as a return unit. Then, your request to have a damaged or defective camera repaired will be sent to our support team for processing. Once you have shipped them, please update us with the tracking details and courier used. We will send out the replacement unit right after we received the faulty unit. The shipping cost is bear by **sender** under shipping term "DAP", whereby if the counter is being returned, cost should be bear by customer and FootfallCam will bear the cost to send to customer.

# Typical Projects

## 5.1 Regular Stores Installation

### How FootfallCam Solution Fit Regular Sized Stores?

- ✓ We offer the entire solution where clients will have a full reporting set with just the purchase of one unit of FootfallCam. We have over 15 sets of ready reports for users to perform analytics on their store performance
- ✓ FootfallCam is able to provide installation support if clients wish to use their own engineers for installation rather than FootfallCam's installer
- ✓ Training for store managers to navigate FootfallCam's web-based software



### Services

- Sales Consultation
- Pre-installation Planning
- Verification
- Ongoing Support & Maintenance
- Server Configuration
- Presentation in Local Language
- Floor Plan Design for Camera Positioning
- IT Configuration
- Training on Software Navigation and Configuration
- Installation Support beyond Standard Working Hours

### Maintenance & Operations

- 1) Project Delivery**  
FootfallCam will handover project upon its completion and provide the deliverables in a presentation
- 2) User Manual**  
User manual is readily available for clients to refer to when they face any difficulties in operating the device
- 3) Training & Feedback**  
We will conduct training to clients to ensure that they are equipped with knowledge to retrieve what they are looking for

### Reports for Retail Stores

- 1) Turn in Rate**  
Measure the number of people that passes by the store actually enters.
- 2) Outside Traffic**  
Measure the potential visitors by looking at the number of people passing by the store that did not enter.
- 3) Dwell Time**  
Measure the average time that visitors stay inside the store
- 4) Sales Conversion**  
Measure the conversion rate of how many people that enters the store actually purchases
- 5) Opening and Closing Time**  
Based on the outside traffic of the visitors, we will suggest whether to extend or shorten the operating hours of the store to improve the number of visitor potentially entering the store

#### Other Reports

- Company Weekly Report
- Company Daily Report
- Predictive Analysis
- Time Comparison Report

- Store Weekly Report
- Store Daily Report
- Comparison of Stores

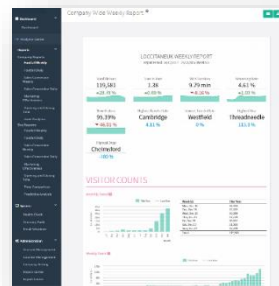

### Weekly Report



### Opening and Closing Time Analysis

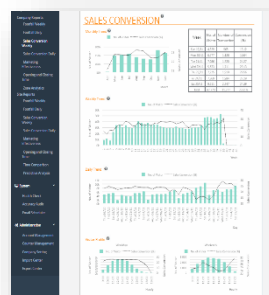

### Sales Conversion Report



## 5.2 Shopping Malls Installation

### How FootfallCam Solution Fit Shopping Malls?

- ✓ FootfallCam will map the camera positioning draft for clients to have an estimate **number of cameras**
- ✓ Clients can maximise rental revenue by having visibility of which zone have the most visitors and charge them accordingly
- ✓ Client will be able to allocate the most optimal tenant mix by having understanding their customer segments and visit behavior. For example, visitors that are going for luxurious brands tend to prefer a less crowded and more quiet area, hence the area with the least visitors should be placed with tenants of similar visitors' behaviors.



### Services

- Sales Consultation
- Pre-installation Planning
- Verification
- Ongoing Support & Maintenance
- Server Configuration
- Presentation in Local Language
- Floor Plan Design for Camera Positioning
- IT Configuration
- Training on Software Navigation and Configuration
- Installation Support beyond Standard Working Hours

### Traffic Flow

Customers have better visibility on the movement of the visitor when the visitor travels from one zone to another.

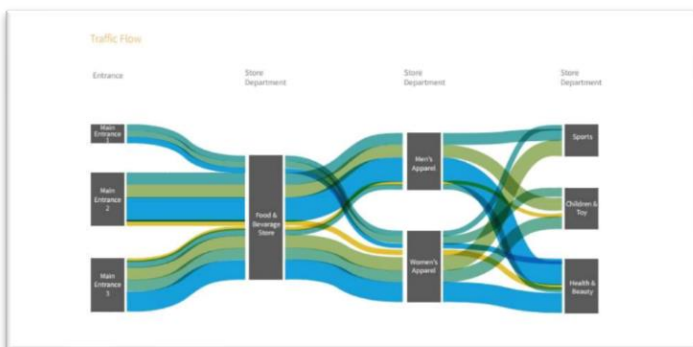

### Reports for Shopping Malls

#### 1) Zone Analytics

Measure the amount of people entering a specific zone to have better understanding on their shopping behavior

#### 2) Marketing Effectiveness

Measure the footfall of before, during and after the campaign to view the difference in trend

#### 3) Opening Closing Hours

Suggestive report whether to change opening and closing hours based on the footfall opportunities for more efficient **staff planning**

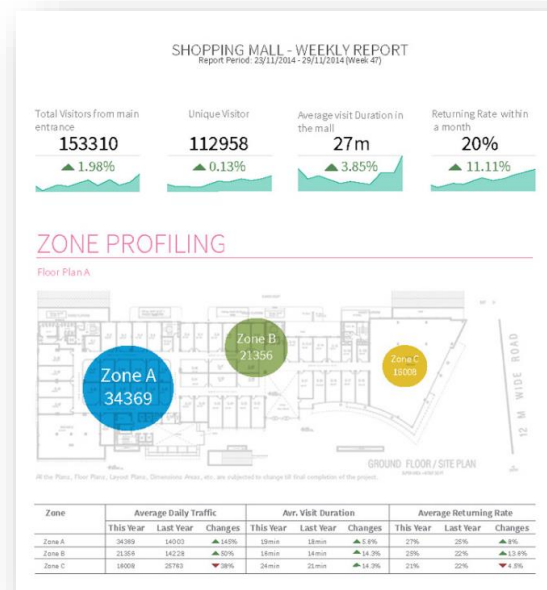

### Maintenance & Operations

#### 1) Project Delivery

FootfallCam will handover project upon its completion and provide the deliverables in a presentation

#### 2) User Manual

User manual is readily available for clients to refer to when they face any difficulties in operating the device

#### 3) Training & Feedback

We will conduct training to clients to ensure that they are equipped with knowledge to retrieve what they are looking for

## 5.3 Retail Chains Rollout

### How FootfallCam Solution Fit Retail Environment?

#### Minimum Maintenance

- ✓ We will liaise with customers' IT team for **automated integration** of data such as importing sales data into our server etc.

#### World Class Service

- ✓ We provide end-to-end services which is **low turnaround time** and feedback loop is short and fast
- ✓ An account manager will be assigned to be a single **point of contact** for customers

#### Centrally Manage One System

- ✓ Customer will only need to manage all data and reports in one system only which is accessible via any web browser

#### Comprehensive Solution

- ✓ FootfallCam **project manages** the entire rollout for retail chains
- ✓ We deliver and handover to customers once the data are ready to be used.
- ✓ We practice data integrity procedures ensuring all processes and data undergo proper steps before handing over to customer

Please refer here to view FootfallCam's RFI

### Services

- Sales Consultation
- Pre-installation Planning
- Verification
- Ongoing Support & Maintenance
- Server Configuration
- Presentation in Local Language
- Floor Plan Design for Camera Positioning
- IT Configuration
- Training on Software Navigation and Configuration
- Installation Support beyond Standard Working Hours

### Deployment

#### 1) Service Level Agreement

Agreement between FootfallCam and customer for the provisioning of services required to support People Counting System

#### 2) Installation Planning

We will plan the installation schedule for you if you are using FootfallCam's engineer to perform installation

#### 3) Project Tracker

To obtain an updated progress on the current status of the project

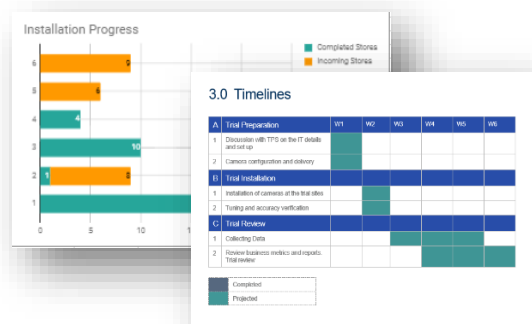

### Maintenance & Operations

#### 1) Project Delivery

FootfallCam will handover project upon its completion and provide the deliverables in a presentation

#### 2) User Manual

User manual is readily available for clients to refer to when they face any difficulties in operating the device

#### 3) Training & Feedback

We will conduct training to clients to ensure that they are equipped with knowledge to retrieve what they are looking for

### Reports for Retail Chain

#### 1) Sales Conversion

Measure the sales conversion rate based on the footfall data

#### 2) Marketing Effectiveness

Measure the footfall of before, during and after the campaign to view the difference in trend

#### 3) Opening Closing Hours

Suggestive report whether to change opening and closing hours based on the footfall opportunities

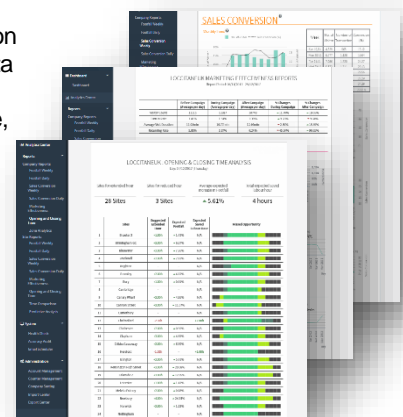

#### Other Reports

- Company Weekly Report
- Company Daily Report
- Predictive Analysis
- Time Comparison Report
- Store Weekly Report
- Store Daily Report
- Comparison of Stores

Sample Reports are available [here](#)

### References

#### Watson

Large scope with projects involving 3000 counters spread out over 7 different countries

#### L'Occitane

Installed over 100 of their stores in UK and Ireland. Worked closely with their IT department due to strict security reasons

#### TH Baker

Luxury jewelry across UK that gained insight on marketing campaign effectiveness

### Trial Plan

- We provide **3 months trial** period for customers to test our units
- Customers with more than **1000 stores** are welcome to apply for the trial program

## 6.0 FAQ

### [1. Are wireless people counter available by FootfallCam?](#)

FootfallCam do not offer wireless people counter. However, Footfallcam only requires 1 cable to install and is powered over ethernet.

### [2. What languages is the control panel available in?](#)

"The Footfallcam control panel is available in 9 different languages and we are constantly expanding. The languages available are English, Chinese, German, Dutch, French, Spanish, Italian, and Persian."

### [3. Is the people counter suitable to be installed in bus?](#)

Our counter would require a network connection and a power supply to operate. If it is mobility counter on bus, you would need to connect up the counter via 3G dongle. You would also need to have a power supply plug for it as the people counter do not have built in battery.

### [4. Are any outdoor counters available for installation?](#)

It is not recommended for the counter to be installed outdoor, but it is feasible as long as there is an overhead protection for the counter.

### [5. Could a WI-Fi dongle be use to connect to the internet instead of a LAN cable?](#)

The data may be transmitted with GPRS albeit with limitation. The counter only have 1 USD port for Wi-Fi adapter. If a Wi-Fi dongle is used, the counter will have access to the internet without the need for LAN connection at the compromisation of Wi-Fi counting data.

### [6. How can the counting of staff be excluded from the Wi-Fi counting data?](#)

For the staff to be eliminated from the data, it could be excluded base on the dwell time result from Wi-Fi count as the staff would stay in the store more than 3 hours. The time frame is adjustable according to the needs of the user of the FootfallCam.

### [7. Why accuracy verification important?](#)

Footfall traffic and conversion rate are key performance metrics for top management. People counters accuracy are under scrutiny. Each poor performance store manager would naturally blame the people counter first. Management cannot manage their stores if they don't have a fully trustworthy people counting system.

### [8. How do you deal with false traffic \(delivery guys, employees going in and out of the store\)?](#)

FootfallCam can give you the statistically valid metrics and trends, especially when it is over a long period and with big sample size.

### [9. How many devices will we need per shop for counting?](#)

The number of devices required is dependent on the height of the ceiling and the width of the entrance. You may key in the data over [here](#) to have an estimation of the number of cameras.

### [10. What is the accuracy level of Footfall data generated?](#)

FootfallCam ensures that the accuracy level of our counters is at least 90% with video proof provided that the user applied for the verification service by FootfallCam.

### [11. If 2 counters are installed side by side in the same entrance, would it count the same person twice?](#)

An individual will not be counted twice even if the counter coverage overlaps an area, this is due to FootfallCam verification specialist having the expertise to exclude overlapping area from each counter

### [12. How to stay up to date with the latest Footfallcam development news?](#)

Users may subscribe to our newsletter through the bottom of the webpage.

### [13. What will happen to the data if internet connectivity is loss?](#)

The data will be uploaded once the counter regain its internet connection, the counter will continue to function as normal, provided counter power is turned on and running when the counter does not have internet connection.

### [14. Is it possible to install the software on a corporate server?](#)

FootfallCam does not permit the users to personally install the software in their server. If users would like to install the Analytic Manager on their coporate server, there will be a service charge for the server installation. Please e-mail [sales@footfallcam.com](mailto:sales@footfallcam.com) for pricing information and requirements.

### [15. How many people in a company will be able to access the reports at any given time?](#)

Head office or headquarters have the option to create as many users account as possible to delegate access to reporting features to other personnels within the business.

### [16. Is a dedicated PC required for every store to operate the FootfallCam?](#)

FootfallCam do not need a dedicated PC to operate. The counter will be connected directly connected to a network. Users that would like to access the camera directly may use their mobile phone to view the control panel on site.

## 7.0 Appendix

### Service Level Agreement (SLA) by FootfallCam

#### Table of Content

1.0 Agreement Overview	1
2.0 Service Agreement Plan	1
3.0 Service Scope and Details	1
4.0 Replacement Price List	4
5.0 Customer Requirements	5
6.0 Periodic Review	5
7.0 Duration	5
8.0 Termination of Service	5
9.0 Reactivation of Service	5
10.0 Confidentiality	5
Appendix	6

#### 1.0 Agreement Overview

This Agreement represents a Service Level Agreement (“SLA” or “Agreement”) between FootfallCam and Customer for the provisioning of services required to support the People Counting system. This Agreement remains valid until superseded by an amendment to this Agreement which has been approved by mutual parties.

#### 2.0 Service Agreement Plan

- ✓ Daily Health Check, each counter will send the heartbeat to the health check report every 15 minutes.
- ✓ Automatic Data Availability Check, to check if device is connected to server, if it is counting, and if count data is being uploaded to server.
- ✓ Issue Preventive Maintenance
- ✓ Accuracy Audit
- ✓ Assist the Customer to answer technical enquiry and ensure fully operational system
- ✓ Counter Reconfiguration
- ✓ First Line, Second Line and Onsite support
- ✓ Manage health check status and data integrity of the system
- ✓ Provide dedicated support staff to work with the Customer.
- ✓ Re-installing server software on client’s new server
- ✓ Reporting software and database support and maintenance
- ✓ Software/ Firmware upgrades
- ✓ Telephone/ Email assistance

#### 3.0 Service Scope and Details:

This section outlines the parameters of all supporting services by FootfallCam.

- I. Support services provided limited to issues relating to operating system and general enquiries.
- II. FootfallCam will proactively monitor counters health check and shall generate weekly report on counters with potential issue to Customer
- III. FootfallCam shall maintain reasonable care on the system maintenance

#### IV. Support Hours:

Asia Office: 9:00 A.M. to 6:00 P.M. Monday – Friday (G.M.T +8)

Europe Office: 9:00 A.M to 5:00 P.M Monday – Friday (G.M.T)

Telephone support line: Asia Office +60 3-9011 2413

Europe Office +44 (0)1344 988681 or +44 (0)1344 988650

Email to [support@footfallcam.com](mailto:support@footfallcam.com)

#### V. Service Scope:

##### a.) **First line support**

- Health Check System: if a camera fails to connect and is being picked up by our Health Check System, an automated alert will be sent to our team and the Customer through email.
- For the first line checking, Customer will be provided with “Counter Checking Form” from FootfallCam and would require store staff to identify the counter LED light, and perform the onsite checking based on guidelines. Customer is then required to update the counter LED light in Health Check and Data Issue Tracker – a support communication page for issue relating to counter and data issue.
- Customer may raise any technical issue regarding hardware or software, via phone or email to FootfallCam
- We aim to resolve 80% of the calls and emails within two (2) working days. All calls and emails will be responded within 24 business hours and best efforts will be made to answer or action the support issues as soon as possible
- Support will be provided over the phone and remote connect into the camera
- This level of support aims to resolve most issues and may involve rebooting equipment, diagnosis and troubleshooting
- Support may require cooperation from a member of staff at the store to reboot equipment and help with preliminary diagnosis
- Most issues (90%) will be resolved by this remote support. Should our technical team concluded that an engineer call-out is required, we will recommend that to your store or head office. When the call out has been authorized, Customer may arrange engineer, liaise with the store to get it sorted

##### b.) **Second Line Support:**

- More complicated issue. E.g. networking issue, system bugs, software faults etc.
- Remote connect support by second level technical team, include up to twenty-four (24) man hours remote connect support
- Action may be performing by store manager as per required
- Accuracy Checking
- Respond within three (3) working days

##### c.) **Site Visit/ Engineer Call-out**

- Issue that is not solved by second level technical team E.g. hardware faults including damaged cable or PoE injector
- Upon diagnosis by first and second level support, engineer call-out to site is recommended
- Engineer to check system on site and shall bring spare units to replace faulty units.
- Customer to fully bear engineer call-out cost

### **3.1 Non-contract Technical Service Rate**

In condition for any additional services provided, Customer agrees to pay pertaining rendered services as specified in Section 4.0, Replacement Price List.

- On-site services are requested  
Engineer will be on-site to support and perform system checking.
- Replacement price  
Replacement parts needed when the unit is faulty or out of the warranty period.

### **3.2 Software License**

- I. FootfallCam grants the Customer a non-exclusive and non-transferable software license to use the people counting system for its own business and in accordance with this Agreement.
- II. FootfallCam may, from time to time, deliver upgrades for software and firmware to improve the performance of the people counting device, at no extra charge.
- III. The Customer acknowledges that the intellectual property rights in the software belongs to FootfallCam and shall not use the license with counters from third party.
- IV. FootfallCam may introduce new features in the service package at the discretion of FootfallCam's Account Manager and Product Line Manager.

### **3.3 Warranty**

- I. Every FootfallCam counter, by default, comes with one-year manufacturer hardware warranty.
- II. FootfallCam will respect the confidentiality of information acquired and therefore, not disclose any such information to third parties.
- III. The warranty period will be effective upon Customer acceptance of the delivery.
- IV. Warranty extension is applicable after the warranty period expired (Appendix I Repair & Extended Warranty)
- V. Customer is allowed to subscribe to warranty extension no later than one (1) month after the initial warranty expired.
- VI. The maximum period of warranty extension the Customer can subscribe is five (5) years.
- VII. Within the warranty period, any replacement services shall be quoted on a discounted price according to Section 4.0, Replacement Price List.
- VIII. After the maximum extended warranty of five (5) years, price incurred for any equipment replacement will be as according to standard price.

### **3.4 Verification**

- I. After the counter has been successfully installed, the accuracy audit and verification shall be performed and expended.
- II. The accuracy audit shall expend a period of fourteen (14) days. The period is subject to condition of network connectivity of the store.

### **3.5 Re-verification**

- I. In the event that the Customer questions the accuracy audit of the FootfallCam counter, a request for re-verification can be made to FootfallCam.
- II. Re-verification request will only be entertained after the Customer request and submit the Re-verification Request Form to FootfallCam.
- III. Customer is required to provide hard evidence E.g. video recordings from the counter under certain hours and screenshots showing any large deviation along with the request submission. No charge will be incurred when re-verification request is submitted under this category.
- IV. In the event that the Customer submitted re-verification request, where FootfallCam Verification Specialist concludes the issue to lie with changing environment, counter reposition, store relocation or any other factors not known or informed to FootfallCam, re-verification charge of USD 70 will be incurred for Customer who did not subscribe to support contract.
- V. Expended period for re-verification shall be the same as verification period, as stated in 3.4 (II).

### **3.6 Returns**

- I. To return a counter for defects, incorrect orders or shipments, or any other reason, Customer is required to request for Return Merchandise Authorization (RMA) Form from FootfallCam.
- II. Customer shall bear the cost associated with returns, by any means.
- III. FootfallCam shall bear the cost associated with sending replacement units to the Customer.
- IV. Returns from Europe countries shall be sent to FootfallCam Europe Office. Returns from Asian countries shall be sent back to FootfallCam Asia Office.

## 4.0 Replacement Price List

### Equipment Replacement Price

Items	Rate Without Support Contract (USD)	Rate with Support Contract (USD) - Standard	Rate with Support Contract-Standard + Extended Warranty (USD)	Rate with Support Contract (USD) - Premium	Rate with Support Contract-Premium + Extended Warranty (USD)
People Counting Camera	559	559	0	459	0
Power over Ethernet (PoE) Injector- only	35	32	32	20	20
Wall Bracket	35	32	32	20	20
4-port PoE Switch	50	45	45	30	30
8-port PoE Switch	100	90	90	60	60
16-port PoE Switch	150	135	135	90	90
Power Cable	8	8	8	8	0

### Others

Items	Rate Without Support Contract (USD)	Rate with Support Contract (USD) - Standard	Rate with Support Contract-Standard + Extended Warranty (USD)	Rate with Support Contract (USD) - Premium	Rate with Support Contract + Extended Warranty (USD)
Engineer Call-out	220	180	180	160	160
Delivery *	Free	Free	Free	Free	Free
Re-verification Accuracy Audit Report	<b>70</b>	55	55	55	55

\* Applicable to the delivery of replacement items only

### Contract Price

Contracts	Rate per Month per Counter (USD)
Basic Support Contract	12.90
Premium Support Contract	25.90
Extended Warranty (Support Contract - Standard)	6
Extended Warranty (Support Contract - Premium)	4

\* All prices quoted excluded VAT/GST.

\* All equipment comes with 1-year manufacture warranty.

\* All prices are subject to change without prior notice.

## 5.0 Customer Requirements

It is the responsibilities of the Customer to characterize issue of the counter, raise Trouble Ticket and provide relevant evidence for FootfallCam to act upon. Customer bears the following responsibilities in support of this Agreement:

- I. In the event of FootfallCam counter issue:
  - a) Request Counter Checking Form from FootfallCam.
  - b) Request Re-verification Form from FootfallCam for accuracy re-verification and provide hard evidence as according to 3.5 Re-verification Part III.
  - c) Request Return Merchandise Authorization (RMA) Form from FootfallCam for counter returns.
  - d) Perform onsite diagnosis based on guidelines.
  - e) Raise any technical issue regarding hardware and software, via phone or email to FootfallCam
  - f) To provide IT and operational staff to actively monitor the health check status on the counter and identify their issue.
  - g) Proactive monitoring of Support Contract and Warranty expiration date through Support Contract and Warranty spreadsheet.
  
- II. Any support email to FootfallCam should provide the following to ensure prompt response:
  - a) Counter serial number
  - b) Clear, detailed description of the issue
  - c) Any subsequent abnormal occurrences
  - d) Screenshot or any other relevant attachments to support

## 6.0 Periodic Review

This Agreement shall be periodically reviewed and revised as required, provided mutual agreement is obtained from FootfallCam and WTC and communicated to all parties involved. FootfallCam reserves the final rights to amend the Agreement.

## 7.0 Duration

This Agreement is valid for one (1) year from the Counter Verified Date (refer to as the date when the counter has completed verification study by FootfallCam Verification Specialist). Both FootfallCam and WTC shall refer to Support Contract and Warranty spreadsheet as the only document with latest updated expiration date.

## 8.0 Termination of Service

Prior to the termination of service, a one-month written notice must be given to FootfallCam. A termination/ deactivation penalty will be incurred for a period of one (1) month valid from the termination date.

## 9.0 Reactivation of Service

In the event the Customer wishes to reactivate FootfallCam service, a reactivation fee of USD20 will be charged per counter. The services provided by FootfallCam might differ depending on the new Service Level Agreement enacted after the reactivation is completed.

## 10.0 Confidentiality

The Customer will treat all information communicated in this Agreement as confidential.



## Support and Extended Warranty (Optional)

Feature	Standard (S)	Premium (P)
	USD 12.90	USD 25.90
Suitable For	Retailers who prefer FootfallCam Support to monitor and support their system on their behalf. And only pay for additional service on rare occasion when necessary	Retailers who prefer FootfallCam Support to fully maintain their system at a cost that is capped at this monthly subscription fee
<u>Hardware Support</u>		
Automatic daily Health Check - System performs automatic nightly check on device, to check if device is connected to server, if it's counting, and if count data is being uploaded to server	✓	✓
Health Check email alert - should any device fail Health Check, an email alert will be sent to the designated email address	✓ Sent to Client to monitor themselves	✓ Sent to Client and FootfallCam Support to monitor on Customer's behalf
1 <sup>st</sup> line Diagnosis	✓ Client to request for Counter Checking Form from FootfallCam Support and perform diagnostic checks	✓ FootfallCam Support will perform the checks, and will proactively call the store to guide member of staff at the store to perform certain diagnostic checks
2 <sup>nd</sup> line Remote support - remote connect to device by FootfallCam Support to investigate and rectify technical issues	✓ Client can request for remote access support in the event that 1 <sup>st</sup> line diagnosis is completed	✓ FootfallCam Support will proactively request for remote access support in the event that 1 <sup>st</sup> line diagnosis is completed
3 <sup>rd</sup> line Technical Service	✓ Client can request for engineer call-out at a discounted rate	✓ Client can request for engineer call-out at a discounted rate
<u>Services</u>		
Accuracy Audit Module -Module available on the Reporting Software -Records video to allow audit of system count with manual counting	✓ Client can perform accuracy audit themselves or request FootfallCam Support to perform accuracy audit	✓ FootfallCam Support to perform accuracy audit
Accuracy Audit to be performed by FootfallCam Support	✓	✓
Counter reconfiguration - for example changes to IT settings or repositioning of counter	✓ Client to fill in installation sheet	✓ FootfallCam Support to fill in installation sheet
Telephone/ Email assistance	✓	✓
Out-of-hour support	X	✓
Staff training on using the Reporting Software (online training)	✓ FootfallCam provide video tutorials and guidelines. Free one-time Skype training,	✓ FootfallCam to train Customer. Free one-time Skype training
Reporting Software & Database support and maintenance - Only applicable to Customers who host the software/database on their own corporate server	✓ Up-to-date version maintenance	✓ Up-to-date version maintenance
Monthly Health Check Audit - Monthly review on the health status of the people counter and the health status trend	✓ FootfallCam Support to inform Customer the likely trend of counter health check	✓ FootfallCam Support to monitor and inform Customer the likely trend of counter health check and suggest on precautions to be taken
Preventive Maintenance - Regularly performed to ensure the device is working as usual - Automated system check on the condition of the device	✓	✓
<u>Upgrades</u>		

Reporting Software updates	✓ Auto Upgrade	✓ Auto Upgrade
Device Firmware upgrades	✓ Auto Upgrade	✓ Auto Upgrade
Re-installing server software on client's new server	✓ USD 300 per server installation	✓ Free server installation including backup and restore
Request new software features	X	✓ * subject to technical review and feasibility assessment
<u>Repair &amp; Extended Warranty</u>		
Device replacement - after the 1 <sup>st</sup> year warranty period * As per RMA process	✓ Replacement unit price as per Replacement Price List at the time of replacement	✓ Replacement unit price as per Replacement Price List at the time of replacement
Extended warranty - free repair/replacement after the 1 <sup>st</sup> year warranty period * As per RMA process	Available to purchase at +USD 6 per month per device for five (5) years	Available to purchase at +USD 4 per month per device for five (5) years
Subscription terms	Price quoted is per device per month. Minimum one (1) year subscription. Payment in advance for the yearly subscription. Annual renewal. Terms & Conditions applied.	Price quoted is per device per month. Minimum one (1) year subscription. Payment in advance for the yearly subscription. Annual renewal. Terms & Conditions applied.

## Counter Checking Form

### Section 2: Quick Survey

#### Step 1: Check LED light colour

Stay for **15 seconds** to observe LED light colour. Refer to **LED Light** indication message below.

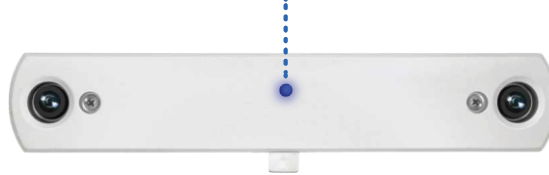

#### Step 2: Check PoE Injector / Midspan lights

Make sure PoE Injector / Midspan has both **Green and Orange** lights.

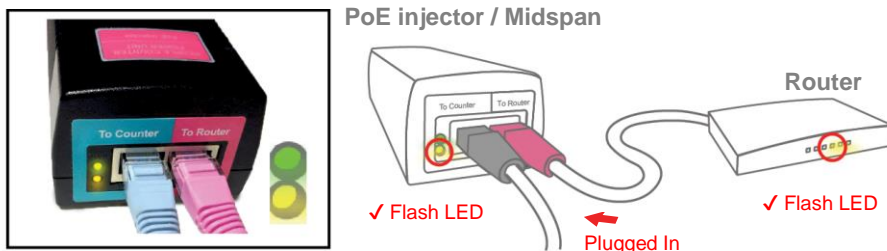

#### Step 3: Make sure power switch is always turned on.

Make sure the power cord is plugged tightly into Midspan / PoE Injector.

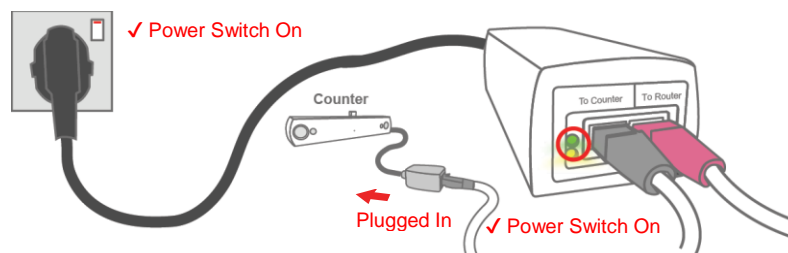

### Section 3: Observation on LED lights

LED colour	Camera no. (left to right from inside the store)	PoE Injectors / Midspan Status
○ No Light	<input type="checkbox"/> Camera 01 <input type="checkbox"/> Camera 02 <input type="checkbox"/> Camera 03 <input type="checkbox"/> Camera 04 <input type="checkbox"/> Camera 05 <input type="checkbox"/> Camera 06 <input type="checkbox"/> Camera 07 <input type="checkbox"/> Camera 08	
● Yellow Light	<input type="checkbox"/> Camera 01 <input type="checkbox"/> Camera 02 <input type="checkbox"/> Camera 03 <input type="checkbox"/> Camera 04 <input type="checkbox"/> Camera 05 <input type="checkbox"/> Camera 06 <input type="checkbox"/> Camera 07 <input type="checkbox"/> Camera 08	
● Green Light	<input type="checkbox"/> Camera 01 <input type="checkbox"/> Camera 02 <input type="checkbox"/> Camera 03 <input type="checkbox"/> Camera 04 <input type="checkbox"/> Camera 05 <input type="checkbox"/> Camera 06 <input type="checkbox"/> Camera 07 <input type="checkbox"/> Camera 08	
● Red Light	<input type="checkbox"/> Camera 01 <input type="checkbox"/> Camera 02 <input type="checkbox"/> Camera 03 <input type="checkbox"/> Camera 04 <input type="checkbox"/> Camera 05 <input type="checkbox"/> Camera 06 <input type="checkbox"/> Camera 07 <input type="checkbox"/> Camera 08	
● Blue Light	<input type="checkbox"/> Camera 01 <input type="checkbox"/> Camera 02 <input type="checkbox"/> Camera 03 <input type="checkbox"/> Camera 04 <input type="checkbox"/> Camera 05 <input type="checkbox"/> Camera 06 <input type="checkbox"/> Camera 07 <input type="checkbox"/> Camera 08	E.g. Camera 05 midspan is working (green & orange light)

Please refer to Counter Troubleshooting and Diagnose Guideline to perform the checking.

## Counter Troubleshooting and Diagnose Guideline

When the LED light of the people counter is showing blue light, it is functioning well. In contrast, when the LED light is not in blue colour, the people counter is facing some issues. Users may follow the LED lights to diagnose the physical failure of the people counter.

### No Light

Possible Causes	Diagnosis
Power switch has been turned off	<input type="checkbox"/> Make sure the power cord is plugged tightly into Midspan / PoE Injectors
Power point faulty	<input type="checkbox"/> The midspan / PoE Injectors should have both orange and green light
Loose cabling in midspan	<input type="checkbox"/> Test the power point with another electrical device's power cord
Loose cabling in router port	<input type="checkbox"/> Unplug cable from Midspan and re-plug tightly again
External physical damage	<input type="checkbox"/> Unplug the FootfallCam grey network cable and re-plug into the router
	<input type="checkbox"/> Check store ceiling and condition of people counter E.g. Device might be damaged by water leakage from ceiling

### Yellow Light

Possible Causes	Diagnosis
Network cable crimped incorrectly	<input type="checkbox"/> Ensure the cable is crimped in the correct sequence and the wires are push to the end of the pin TIA/EIA 568B colour code for Internet cable: <i>White-orange, orange, white-green, blue, white-blue, green, white-brown, brown</i>
Loose network cable	<input type="checkbox"/> Check network cable from counter to Midspan / PoE Injector <input type="checkbox"/> The midspan / PoE Injectors should have both orange and green light

### Green Light

Possible Causes	Diagnosis
Store network down	<input type="checkbox"/> Check network provider's internet service
An IP address conflict with third party devices	<input type="checkbox"/> Type the counter IP address in a Google Chrome new tab in the store PC E.g. 10.102.23.110 <input type="checkbox"/> Users will be redirected into Control Panel Login page and check IT settings on the network page
Firewall blocked	<input type="checkbox"/> Unblock Port 80, Port 22 and Port 443 <input type="checkbox"/> Unblock FootfallCam server <a href="http://footfallcounter.com">http://footfallcounter.com</a> , <a href="http://91.109.10.77">http://91.109.10.77</a> and <a href="http://54.85.80.97">http://54.85.80.97</a>
Unable to resolve DNS issue	<input type="checkbox"/> Check server address whether it was set correctly
Functionality of the router port	<input type="checkbox"/> Change the Cat 5e network cable from the current port to another available port or swap with other ports in router
Proxy password expired	<input type="checkbox"/> Check proxy server connectivity whether the proxy has expired.
A lack of available network bandwidth	<input type="checkbox"/> Make sure other system resources are not using all the available bandwidth <input type="checkbox"/> Make sure the counter IP address assigned correctly
Incorrect network settings	<input type="checkbox"/> Login into counter through Wi-Fi SSID and check IP address
Others	<input type="checkbox"/> Power cycling FootfallCam people counter - Power off people counter for 5 minutes, and power on again - Unplug both pink cable and grey internet cable from Midspan/ PoE switches, and re-plug again after 5 minutes

### Red Light

Possible Causes	Resolutions
System stuck during boot up	<input type="checkbox"/> Power cycling FootfallCam people counter - Power off people counter for 5 minutes, and power on again - Unplug both pink cable and grey internet cable from Midspan/ PoE switches, and re-plug again after 5 minutes

## FootfallCam Re-Verification Request Form

If you would like our specialist to recheck the accuracy of the counter, you may kindly fill in the below form, and you may get notified once the request has been approved.

Basic Information	
Company Name	
Company ID: Do not have it? <a href="#">Register now</a>	<i>When you register the footfallCam software account, the company ID will auto generated for you and display under your profile</i>
Branch Name	
Counter Serial Number	
Counter Mounting Height	_____m
Store Ready date	<ul style="list-style-type: none"> <li>• Store is in operation now</li> <li>• Store is under renovate and will re-open on _____</li> </ul>
Reason of Re-check the accuracy (Attached photos if any)	
Email Result to	
Remarks	

For FootfallCam Internal Use Only	
Application Received Date	
Review by	
Date of review	
Status	<input type="checkbox"/> Approved <input type="checkbox"/> Disapproved
Comments/ Details	

## Return Merchandise Authorization (RMA) Request Form

Please provide complete detailed answer, complete the form and send to [sales@footfallcam.com](mailto:sales@footfallcam.com) for any returns and refunds of merchandise.

CUSTOMER INFORMATION	
Company Name	
Address	
Contact Person	
E-Mail	
Contact Number	

PRODUCT INFORMATION	
Serial Number	
<u>Return Questions</u>	
1. Has the package been opened?	
2. Have you tried to plug in the camera?	
<u>Items to be Returned</u>	
1. Camera	
2. PoE	
3. Cat5E Cable	
4. Memory SD Card	
Reason for Return	

PLEASE FILL UP ALL THE FIELDS AND SUBMIT THIS APPLICATION FORM TO [Sales@footfallcam.com](mailto:Sales@footfallcam.com)

INTERNAL USE ONLY	
Application Received Date	_____
Reviewed and approved by	_____ Date _____